

**A**

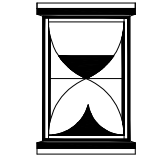

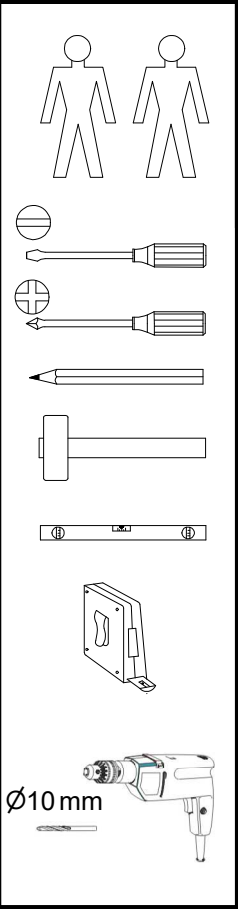

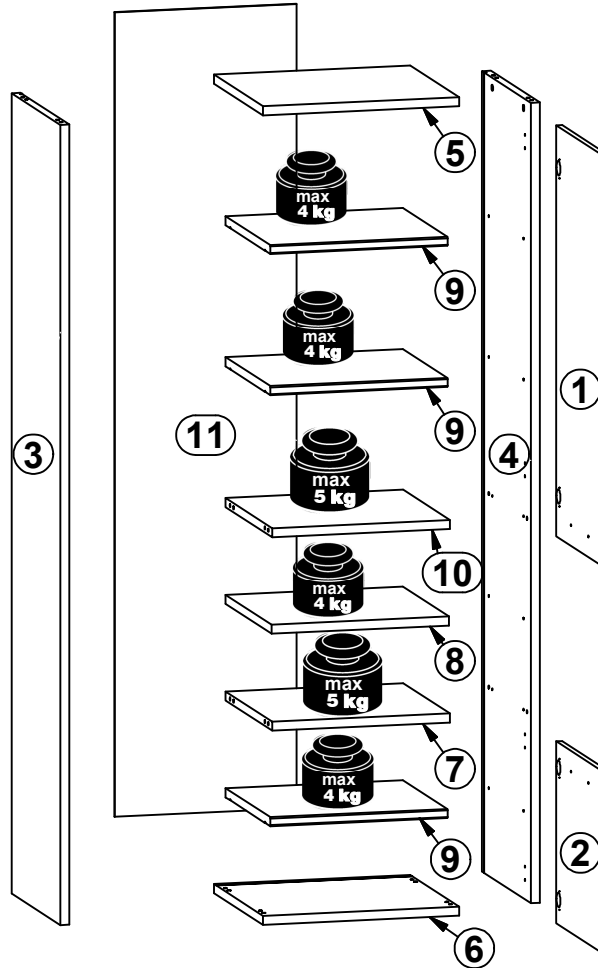
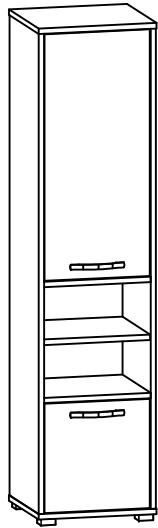

60 min

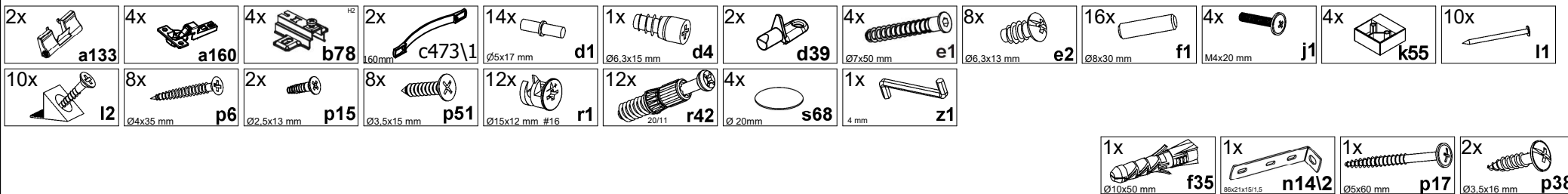

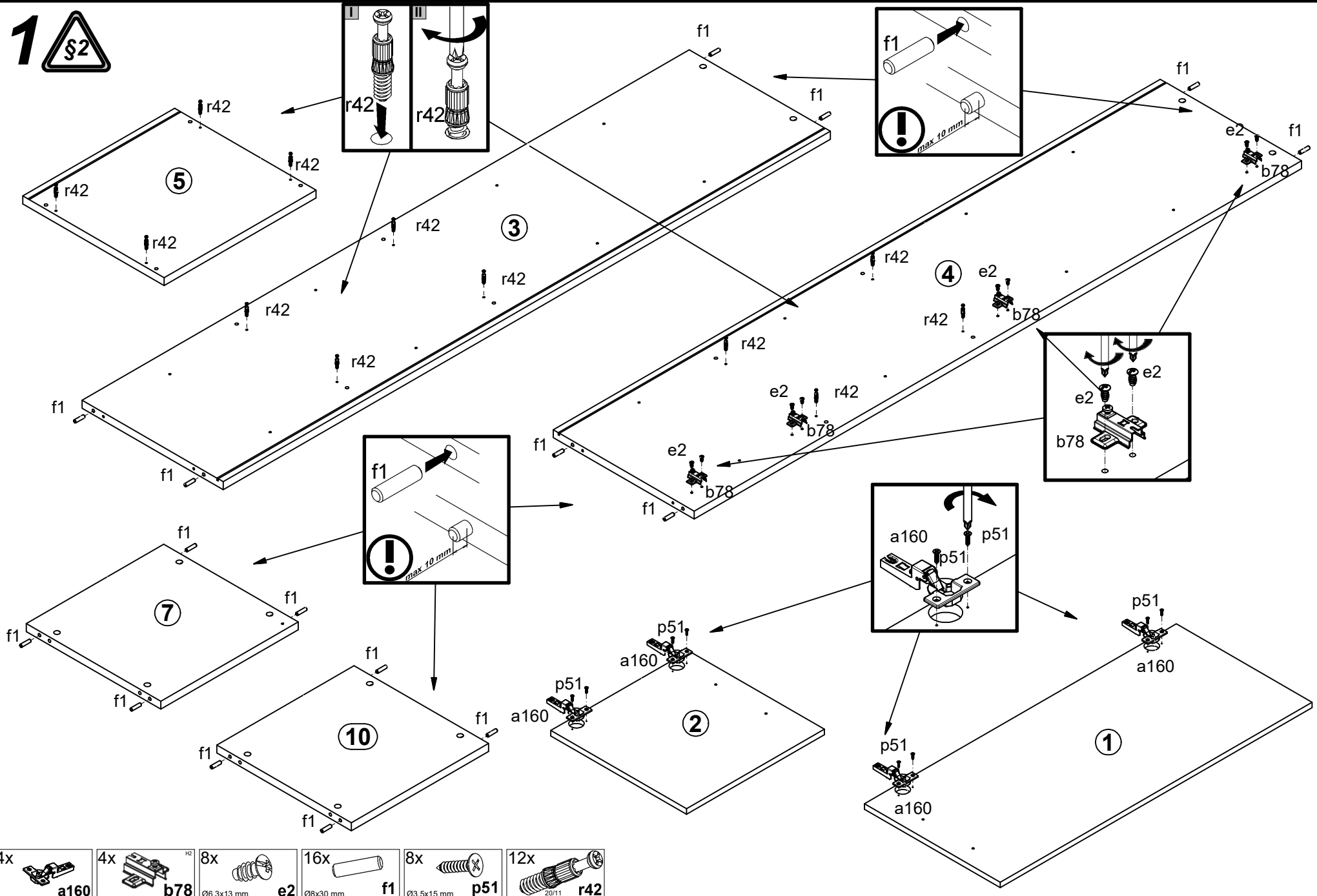
A	B	C (mm)			D
1	S387-0004	994	433	15	2/2
2	S387-0005	440	433	15	2/2
3	S387-1004/A	1936	450	22	1/2
4	S387-1005/A	1936	450	22	1/2
5	S387-2003	484	451	22	2/2
6	S387-2004	484	451	22	2/2
7	S387-3005	438	429	22	2/2
8	S387-3006	437	424	22	2/2
9	S387-3007	437	412	22	2/2
10	S387-3012	438	429	22	2/2
11	S387-9003	1946	448	2,5	1/2



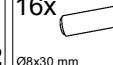
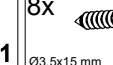
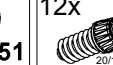

- 4x  a160
- 4x  b78
- 8x  e2 Ø6.3x13 mm
- 16x  f1 Ø8x30 mm
- 8x  p51 Ø3.5x15 mm
- 12x  r42 20/11

2 

I

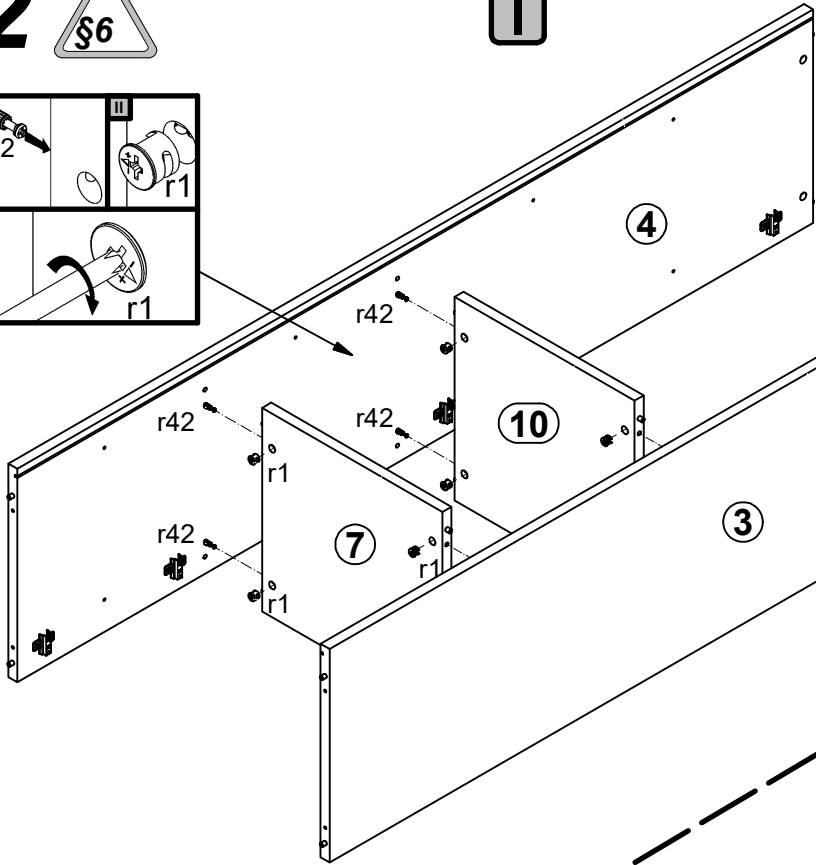
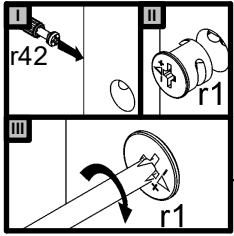

II

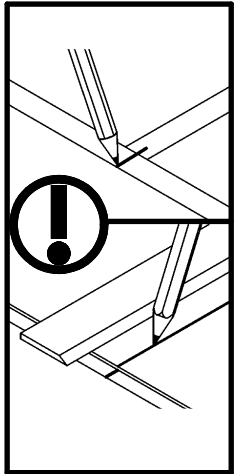
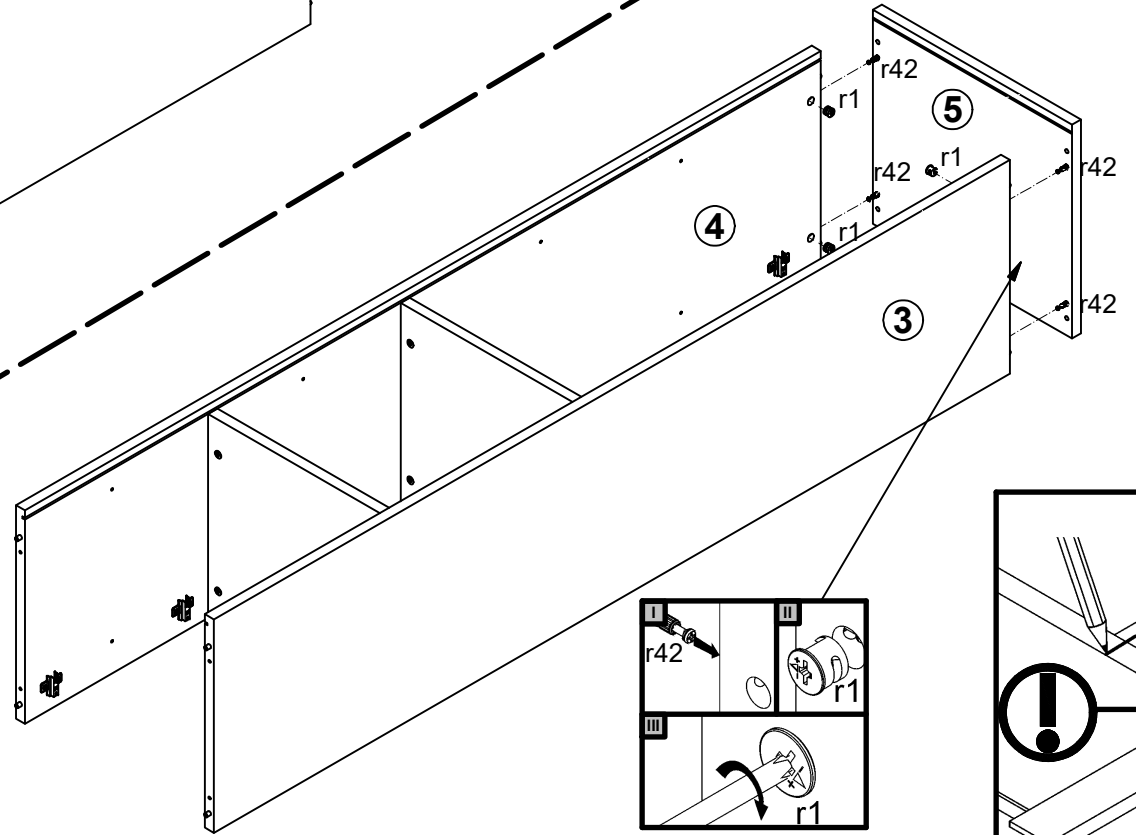

8x  r1  
Ø15x12 mm #16





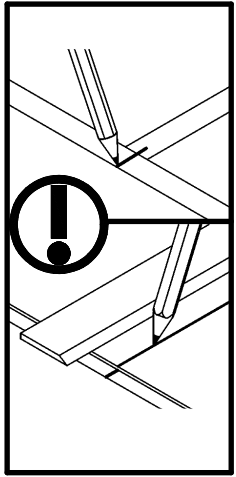
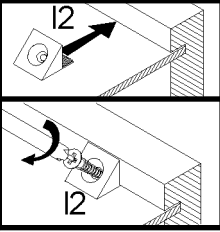
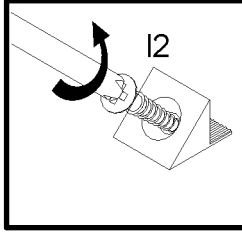
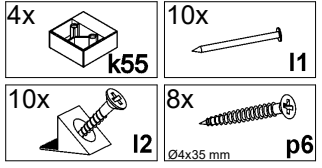
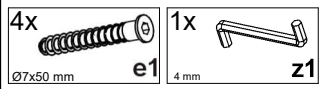
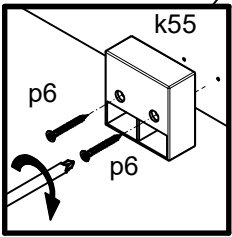
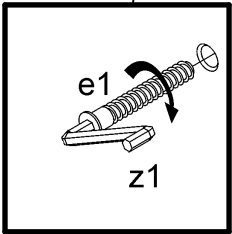
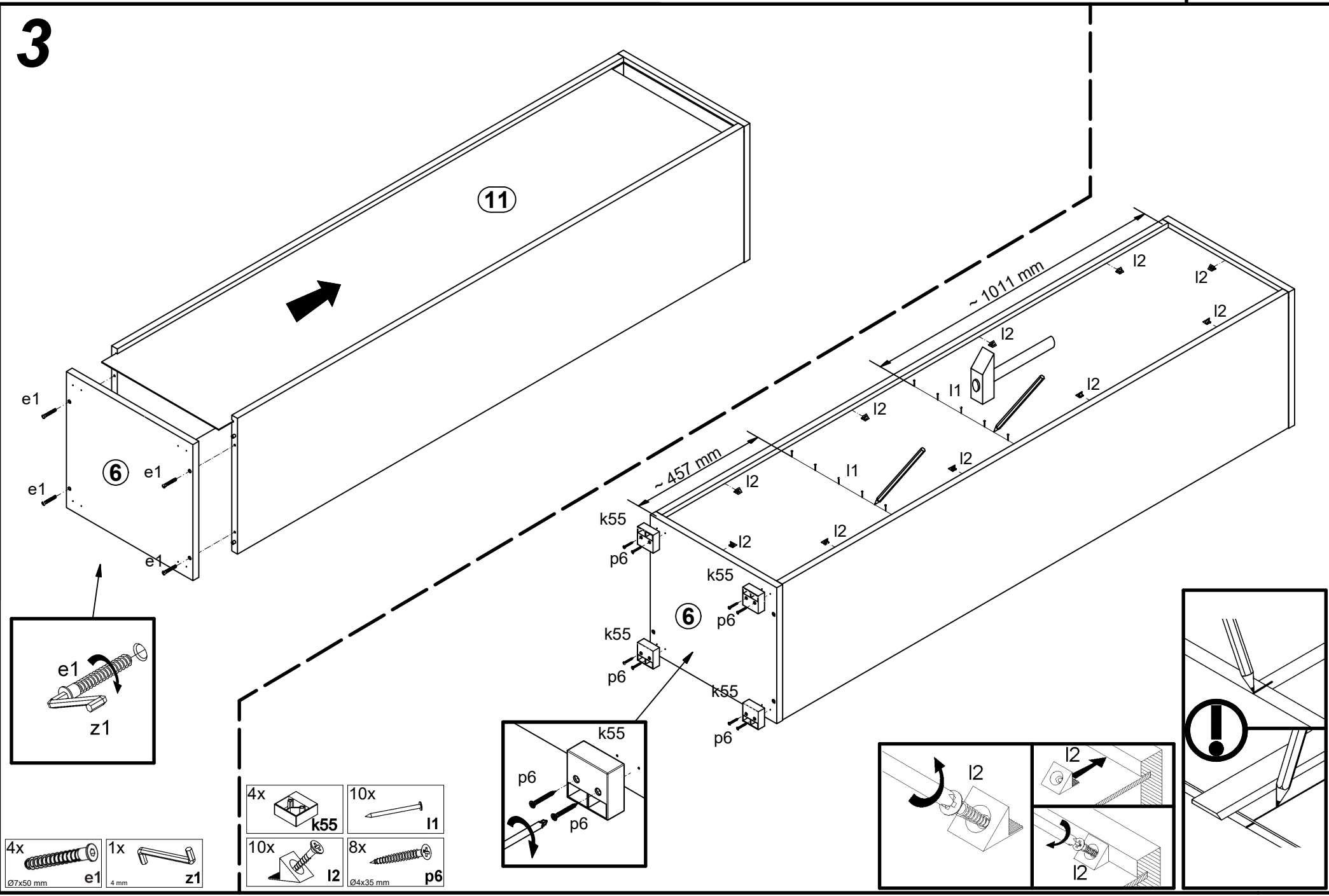

4x  r1  
Ø15x12 mm #16

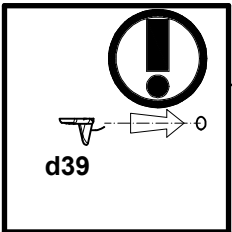
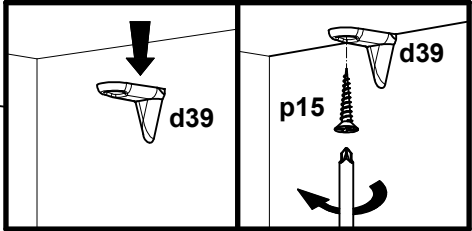
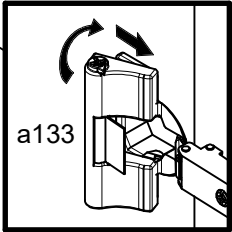
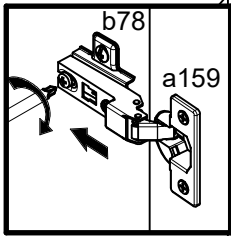
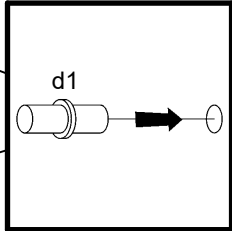
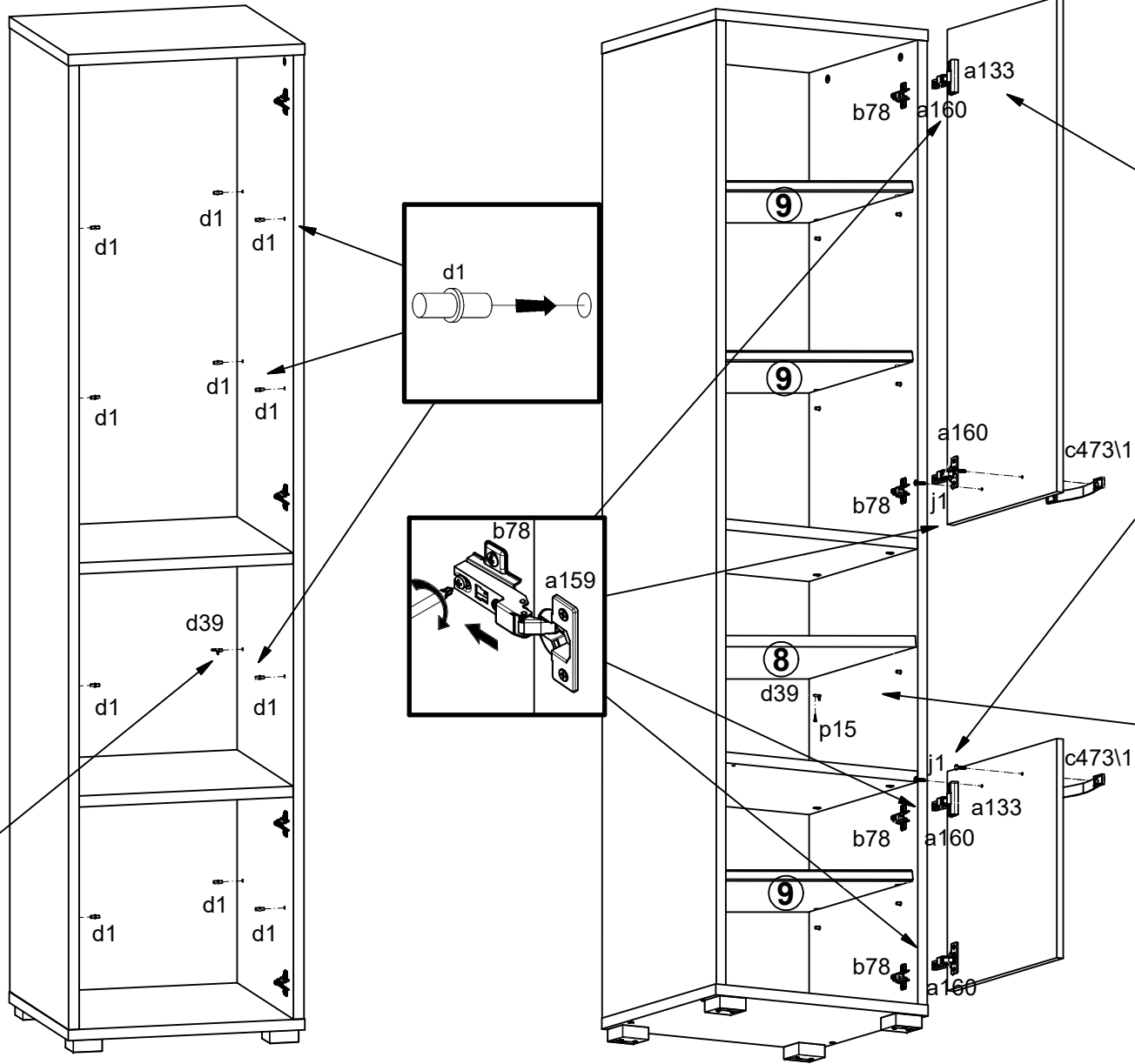
# 3



# 4



- |  |  |
|--|--|
| 2x<br><br><b>a133</b>         | 2x<br><br>160mm <b>c473\1</b>   |
| 14x<br><br>Ø5x17 mm <b>d1</b> | 2x<br><br>Ø2.5x13 mm <b>d39</b> |
| 4x<br><br>M4x20 mm <b>j1</b>  | 2x<br><br>Ø2.5x13 mm <b>p15</b> |

5

